

# datavideo

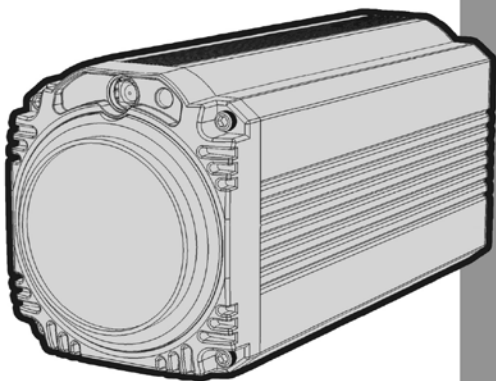

**HD BLOCK CAMERA**

**BC-80**

**Instruction Manual**

[www.datavideo.com](http://www.datavideo.com)

# Table of Contents

<b>FCC COMPLIANCE STATEMENT .....</b>	<b>4</b>
<b>WARNINGS AND PRECAUTIONS.....</b>	<b>4</b>
<b>WARRANTY.....</b>	<b>5</b>
STANDARD WARRANTY .....	5
TWO YEAR WARRANTY.....	5
<b>DISPOSAL.....</b>	<b>6</b>
<b>1. INTRODUCTION.....</b>	<b>7</b>
FEATURES .....	7
<b>2. SYSTEM DIAGRAM.....</b>	<b>8</b>
<b>3. CONNECTIONS.....</b>	<b>9</b>
FRONT VIEW .....	9
REAR PANEL.....	10
<b>4. IR REMOTE CONTROL .....</b>	<b>13</b>
<b>5. OSD MENU OPTIONS .....</b>	<b>18</b>
<b>6. DIP SWITCH SETTINGS .....</b>	<b>28</b>
<b>7. RS-422 CONTROL PROTOCOL .....</b>	<b>29</b>
7.1 PIN DESCRIPTIONS .....	29

7.2 CONTROL OPERATION GUIDE .....	29
7.2.1 Overview of VISCA.....	29
7.2.2 VISCA Communication Specifications.....	31
7.2.3 VISCA Device Setting Command.....	34
7.2.4 VISCA Command/ACK Protocol .....	35
7.2.5 VISCA Camera-Issued Messages .....	36
7.2.6 BC-80 Commands.....	37
<b>8. DVIP CONTROL OPERATION GUIDE.....</b>	<b>47</b>
8.1 PHYSICAL LAYER .....	47
8.2 GENERAL CONNECTION INFORMATION.....	47
8.3 PACKET DATA .....	47
<b>9. FIRMWARE UPGRADE.....</b>	<b>63</b>
<b>10. DIMENSIONS.....</b>	<b>64</b>
<b>11. SPECIFICATIONS .....</b>	<b>65</b>
<b>SERVICE AND SUPPORT .....</b>	<b>67</b>

#### **Disclaimer of Product & Services**

The information offered in this instruction manual is intended as a guide only. At all times, Datavideo Technologies will try to give correct, complete and suitable information. However, Datavideo Technologies cannot exclude that some information in this manual, from time to time, may not be correct or may be incomplete. This manual may contain typing errors, omissions or incorrect information. Datavideo Technologies always recommend that you double check the information in this document for accuracy before making any purchase decision or using the product. Datavideo Technologies is not responsible for any omissions or errors, or for any subsequent loss or damage caused by using the information contained within this manual. Further advice on the content of this manual or on the product can be obtained by contacting your local Datavideo Office or dealer.

## FCC Compliance Statement

This device complies with part 15 of the FCC rules. Operation is subject to the following two conditions:

- (1) This device may not cause harmful interference, and
- (2) This device must accept any interference received, including interference that may cause undesired operation.

## Warnings and Precautions



1. Read all of these warnings and save them for later reference.
2. Follow all warnings and instructions marked on this unit.
3. Unplug this unit from the wall outlet before cleaning. Do not use liquid or aerosol cleaners. Use a damp cloth for cleaning.
4. Do not use this unit in or near water.
5. Do not place this unit on an unstable cart, stand, or table. The unit may fall, causing serious damage.
6. Slots and openings on the cabinet top, back, and bottom are provided for ventilation. To ensure safe and reliable operation of this unit, and to protect it from overheating, do not block or cover these openings. Do not place this unit on a bed, sofa, rug, or similar surface, as the ventilation openings on the bottom of the cabinet will be blocked. This unit should never be placed near or over a heat register or radiator. This unit should not be placed in a built-in installation unless proper ventilation is provided.
7. This product should only be operated from the type of power source indicated on the marking label of the AC adapter. If you are not sure of the type of power available, consult your Datavideo dealer or your local power company.
8. Do not allow anything to rest on the power cord. Do not locate this unit where the power cord will be walked on, rolled over, or otherwise stressed.
9. If an extension cord must be used with this unit, make sure that the total of the ampere ratings on the products plugged into the extension cord do not exceed the extension cord rating.
10. Make sure that the total amperes of all the units that are plugged into a single wall outlet do not exceed 15 amperes.
11. Never push objects of any kind into this unit through the cabinet ventilation slots, as they may touch dangerous voltage points or short out parts that could result in risk of fire or electric shock. Never spill liquid of any kind onto or into this unit.

12. Except as specifically explained elsewhere in this manual, do not attempt to service this product yourself. Opening or removing covers that are marked "Do Not Remove" may expose you to dangerous voltage points or other risks, and will void your warranty. Refer all service issues to qualified service personnel.
13. Unplug this product from the wall outlet and refer to qualified service personnel under the following conditions:
  - a. When the power cord is damaged or frayed;
  - b. When liquid has spilled into the unit;
  - c. When the product has been exposed to rain or water;
  - d. When the product does not operate normally under normal operating conditions. Adjust only those controls that are covered by the operating instructions in this manual; improper adjustment of other controls may result in damage to the unit and may often require extensive work by a qualified technician to restore the unit to normal operation;
  - e. When the product has been dropped or the cabinet has been damaged;
  - f. When the product exhibits a distinct change in performance, indicating a need for service.

## Warranty

### Standard Warranty

- Datavideo equipment is guaranteed against any manufacturing defects for one year from the date of purchase.
- The original purchase invoice or other documentary evidence should be supplied at the time of any request for repair under warranty.
- Damage caused by accident, misuse, unauthorized repairs, sand, grit or water is not covered by this warranty.
- All mail or transportation costs including insurance are at the expense of the owner.
- All other claims of any nature are not covered.
- Cables & batteries are not covered under warranty.
- Warranty only valid within the country or region of purchase.
- Your statutory rights are not affected.

### Two Year Warranty

- All Datavideo products purchased after 01-Oct.-2008 qualify for a free one year extension to the standard Warranty, providing the product is registered with Datavideo within 30 days of



purchase. For information on how to register please visit [www.datavideo.com](http://www.datavideo.com) or contact your local Datavideo office or authorized Distributors.

- Certain parts with limited lifetime expectancy such as LCD Panels, DVD Drives, Hard Drives are only covered for the first 10,000 hours, or 1 year (whichever comes first).

Any second year warranty claims must be made to your local Datavideo office or one of its authorized Distributors before the extended warranty expires.

## Disposal



### For EU Customers only - WEEE Marking

This symbol on the product or on its packaging indicates that this product must not be disposed of with your other household waste. Instead, it is your responsibility to dispose of your waste equipment by handing it over to a designated collection point for the recycling of waste electrical and electronic equipment. The separate collection and recycling of your waste equipment at the time of disposal will help to conserve natural resources and ensure that it is recycled in a manner that protects human health and the environment. For more information about where you can drop off your waste equipment for recycling, please contact your local city office, your household waste disposal service or the shop where you purchased the product.



official documents.

**CE Marking** is the symbol as shown on the left of this page. The letters "CE" are the abbreviation of French phrase "Conformité Européene" which literally means "European Conformity". The term initially used was "EC Mark" and it was officially replaced by "CE Marking" in the Directive 93/68/EEC in 1993. "CE Marking" is now used in all EU

# 1. Introduction

The BC-80 Block Camera is a small HD camera with an infra-red remote control. It can be used for HD high quality shooting in an environment where space is limited. The image resolution is 1920x1080. The BC-80 provides 30x optical focus, and the image output interfaces are SDI and HDMI. A tally light indicator sits above the BC-80 camera lens. The control protocol supports SONY VISCA so that the camera can be controlled via RS-422 or DVIP interface.

## Features

- HD Resolution: 1/2.8" High Definition 2.0 M Pixels progressive CMOS sensor
- 30x optical zoom
- High definition formats supported:  
1080/ 59.94p, 1080/ 50p, 1080/ 59.94i, 1080/ 29.97p, 1080/ 25p, 1080/ 50i, 720/ 59.94p, 720/50p
- Digital Noise Reduction Function (DNR) to reduce the noise and enable clearer image under low light conditions.
- Video Output: SDI + HDMI synchronously.
- Tally LED Design (RS-422/ DVIP Operation)
- Supports SONY VISCA Protocol
- Supports DVIP Control Protocol

## 2. System Diagram

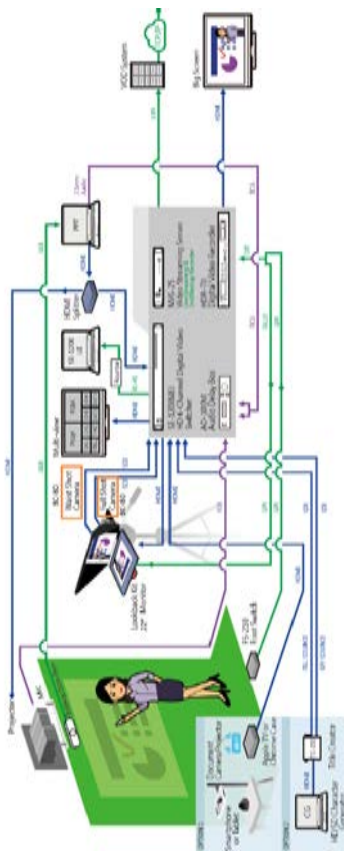



### 3. Connections

#### Front View

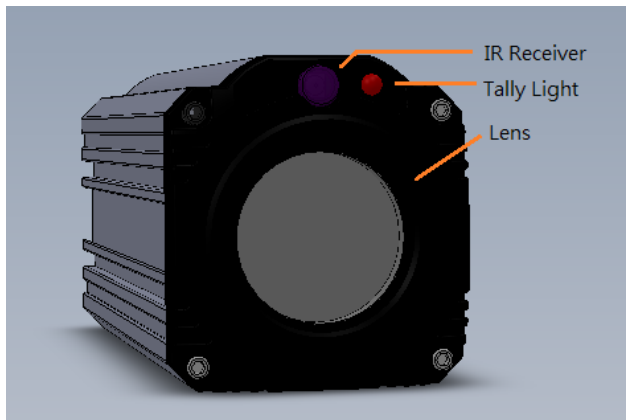

<b>IR Receiver</b>	Receives signal from the IR remote control.
<b>Tally Light</b>	As the camera is booting the tally light stays <b>solid green</b> and turns <b>solid red</b> for about three seconds just before the boot is complete. The tally light remains <b>solid green</b> after the camera finishes booting.
<b>Lens</b>	Camera lens for capturing images.

## Rear Panel

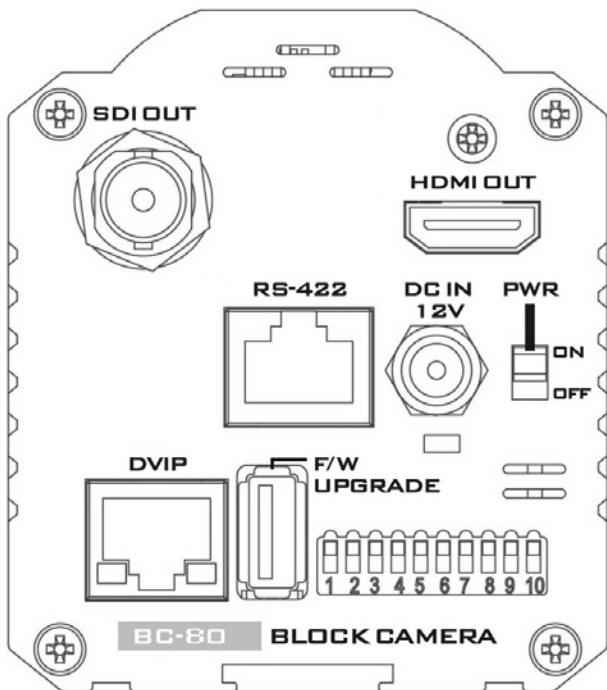



### SDI Output

Video output connected to SDI monitor.



### HDMI Output

Video output connected to HDMI port of the monitor.



### RS-422 Control Port

Remote control port using the RS-422 control protocol. See [RS-422 Control Protocol](#) for details.



### 12V DC Power IN

DC in socket connects the supplied 12V PSU. The connection can be secured by screwing the outer fastening ring of the DC In plug to the socket.



### Power Switch

Turns ON/OFF the camera.



### Power LED Indicator

Green: Power ON  
OFF: Power OFF



### DVIP Control Port

Remote control port using the DVIP control protocol. See [DVIP Control Operation Guide](#) for details.



### **Firmware Upgrade Port**

Connects USB drive for firmware upgrade. For details, please refer to the [Firmware Upgrade](#) section.







### **DIP Switch**



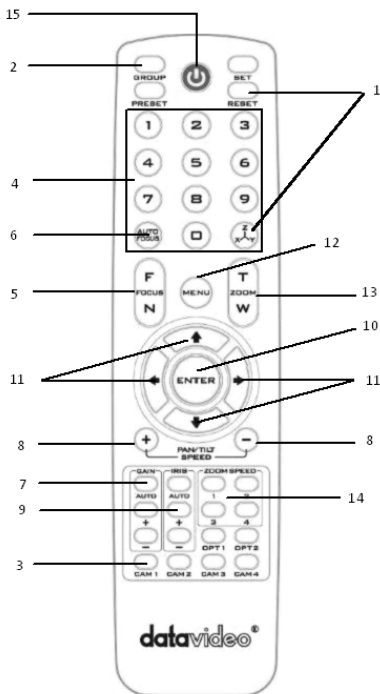

DIP Switch sets the camera VISCA ID, Remote Control Protocol, and Resolution, Video Mode Selection Method, and Camera ID Assignment. For details, please refer to the [DIP Switch Settings](#) section.



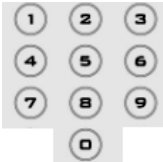

## 4. IR Remote Control

Use the IR remote control that comes with the product package to operate the BC-80 Block Camera. The IR remote control functions are described in the table below.



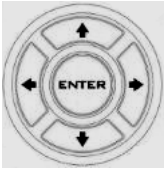

No	Item	Description
1	<p><b>Reset</b></p>  	<p>Press RESET or XYZ button to return the camera lens to the default zoom position (Z:0000).</p>
2	<p><b>Group</b></p> 	<p>Not Applicable</p>
3	<p><b>Camera Select</b></p> 	<p><b>Select CAM1-CAM4 in a multi-camera environment</b>          Press Camera Select buttons to select a camera from Camera 1 to Camera 4 in a multi-camera environment.</p> <p>However before using the Camera Select function, first assign an ID number (CAM 1 – CAM 4) to the camera intended for remote control operation by adjusting the DIP switch located at the rear of the camera. Please refer to <a href="#">DIP Switch Settings</a> section for details.</p>
4	<p><b>Preset Setting</b></p> 	<p>Not Applicable</p>

5	<p style="text-align: center;"><b>Focus Setup</b></p> 	<p><b>Manually focus camera lens on a subject</b>  Press either <b>(F)</b> FAR button or <b>(N)</b> NEAR button to manually focus the camera lens onto the subject.</p> <p>Before using manual focus, make sure Auto Focus mode is turned off by pressing the <b>AUTO FOCUS</b> button.</p>
6	<p style="text-align: center;"><b>Auto Focus Control</b></p> 	<p><b>Automatically focus camera lens on a subject</b>  Press <b>AUTO FOCUS</b> button and camera lens will be automatically focused on the subject.</p>
7	<p style="text-align: center;"><b>Gain Control</b></p> 	<p><b>Adjust Brightness</b>  Press <b>GAIN+</b> button to increase the brightness or <b>GAIN-</b> button to decrease the brightness.</p> <p>Press <b>AUTO</b> button to activate auto Gain Control and press again to exit.</p>
8	<p style="text-align: center;"><b>P/T Speed</b></p> 	<p><b>Adjust Pan/ Tilt Speed</b>  Not Applicable</p>

9	<p><b>Auto Iris Control</b></p> 	<p><b>Make the subject appear brighter</b> Adjust the iris opening (aperture), to control the amount of light coming through the lens (i.e. the "exposure"). Press <b>IRIS+</b> button to enlarge the iris opening to allow more light to come in so that the subject appears brighter and press <b>IRIS-</b> button to shrink the iris opening to allow less light to come in so that the subject appears less bright.</p> <p>Press <b>AUTO</b> button activate auto Iris Control and press again to exit.</p>
10	<p><b>ENTER</b></p> 	<p><b>ENTER</b> Press <b>ENTER</b> key to select a particular menu option or confirm a parameter value.</p>
11	<p><b>Direction Arrows</b></p> 	<p><b>Browse Menu Options</b> Press <b>UP, DOWN, LEFT</b> and <b>RIGHT</b> arrow buttons to browse the menu options or adjust parameter values.</p>
12	<p><b>Enter/ Exit Camera Menu</b></p> 	<p>Press the <b>MENU</b> button to Enter or Exit the Camera OSD Menu</p>



13	<p><b>Zoom In/Out Buttons</b></p> 	<p><b>Zoom</b> Press either <b>(T)</b> TELE button to zoom in on the subject such that it appears to be close to the camera or <b>(W)</b> WIDE button to zoom out from the subject such that it appears to be far away from the camera.</p>
14	<p><b>Zoom Speed Buttons (4 speed selection)</b></p> 	<p><b>Adjust Zoom In/Out Speed</b> Press the ZOOM SPEED buttons to switch to different zoom speeds (4 being the highest and 1 being the lowest).</p>
15	<p><b>Power Button</b></p> 	<p>Switch <b>ON/OFF</b> camera</p>

## 5. OSD Menu Options

On-Screen Menu allows the user to change various camera settings such as shooting conditions and the system setup. Press **Menu** button on the **IR remote control** to enter the on-screen menu as shown below.

[MAIN MENU]
1: Camera Set (Normal)
2: Video Output
3: Remote Control
4: System
5: Camera Set (Advance)
6: Escape

Main Menu	
<b>1. Camera Set (Normal)</b>	<b>White Balance</b> Color temperature adjustment to make the image look more natural.
	<b>IRIS</b> This is an adjustable aperture used to control the amount of light coming through the lens. The more the iris is opened, the more light it lets in and the brighter the scene will be.
	<b>AGC</b> The setting that automatically adjusts the amplification of the signal from the camera sensor.
	<b>DNR</b> Digital Noise Reduction digitally removes any noise found in each image, resulting in a clearer image.
<b>2. Video Output</b>	<b>Selection Way</b> This option configures how you can select the video mode. Enabling DIP SW 8 allows you to use the DIP

	switch to set the video mode instead of the remote control.
	<p><b>Pattern</b> Pattern generates color bars for color calibration.</p>
<b>3. Remote Control</b>	Remote control settings
<b>4. System</b>	System configuration
<b>5. Camera Set (Advance)</b>	<p><b>Fog Correction</b> When the surrounding area of the subject is foggy and of a low contrast, turning on fog correction will make the subject appear clearer.</p>
	<p><b>Aperture</b> Aperture adjusts the image sharpness. Increasing the aperture setting so that the foreground and background of your images appear sharp.</p>
	<p><b>Vivid Effect</b> Vivid effect adjusts the color saturation which is basically the intensity of color in an image.</p>
	<p><b>Pedestal Effect</b> The pedestal effect enables exposure compensation which will engage the iris or auto gain control depending on the shooting situation. For best results we recommend setting the pedestal effect to 4 or 5. The pedestal effect allows the camera to brighten up the image captured as you zoom in.</p>
	<p><b>Backlight Correction</b> Use this function when the background is brighter than the subject.</p>
<b>6. Escape</b>	Exits the MENU

Main Options	Camera Set (Normal)	Video Output	Remote Control	System	Camera Set (Advance)	Escape
Sub-Options	1. Camera Name	1. Selection Way	1. PAN/TILT Reverse	1. Display	1. Camera Name	
	2. Mirror	2. Video Mode	2. Remote Source	2. Set Motor	2. Mirror	
	3. White Balance	3. CV Mode	3. Set RS-422	3. Tally Light	3. White Balance	
	4. Focus	4. Pattern	4. Set DVIP	4. Reset All	4. Focus	
	5. Iris	5. Escape	5. Set IR	5. Update Software	5. Iris	
	6. AGC		6. PTZ INFO. output	6. Escape	6. AGC	
	7. Escape		7. Escape		7. Fog Correction	
					8. Aperture	
					9. Vivid Effect	
					10. Pedestal Effect	
					11. Backlight Correct	
					12. Day/Night Mode	
					13. Shutter	
					14. Gamma Mode	
					15. WD Mode	
					16. Escape	

First Level Main Options	Second Level Sub-Options	Third Level Parameters	Fourth Level Parameters	Sub-Option Descriptions
1. Camera Set (Normal)	1. Camera Name	NAME		
		DISPLAY SW	ON/OFF	
		POSITION	LOWER LEFT	
			UPPER RIGHT	

	2. Mirror	ESCAPE			
		H+V			
		V			
		H			
	3. White Balance	MODE	AWB(AUTO)		
			AWC (ONE PUSH)		
			MWB (MANUAL)		
			3200K (INDOOR)		
			6500K (OUTDOOR)		
			4200K (FLUO)		
		SMART ATW	OFF		
			SMART1/2/3		
		MWB RED COMPONENT	0~128~255		
		MWB BLUE COMPONENT	0~128~255		
	ESCAPE				
	4. Focus	FOCUS MODE	AUTO		
			MANUAL		
		AF SENSITIVITY	LOW		
			NORMAL		
	FOCUS SPEED	1~4			
	ESCAPE				
	5. Iris	IRIS MODE	AUTO IRIS		
			MANUAL		
		MANUAL IRIS LEVEL	F1.6		
			F2.0		
			F2.4		
			F2.8		
			F3.4		
			F4		
			F4.8		
			F5.6		
			F6.8		
F8					
F9.6					
F11					
F14					
CLOSE					
ESCAPE					
6. AGC	DAY (COLOR) AGC	AGC MODE	OFF		
			ON		

			MANUAL GAIN	0 dB ~ GAIN LIMIT
			GAIN LIMIT	9 dB
				12 dB
				15 dB
				18 dB
				21 dB
				24 dB
				27 dB
				30 dB
				33 dB
			36 dB	
39 dB				
DNR	DNR (AT AGC ON)	ON		
		OFF		
	DNR LEVEL	0		
		1		
		2		
		3		
4				
5				
ESCAPE				
ESCAPE				
7. Escape				
2. Video Output	1. Selection Way	BY MENU		
		BY SWITCH		
	2. Video Mode	1080i60		
		1080i50		
		720p60		
		720p50		
		1080p30		
		1080p25		
		1080p60		
	1080p50			
3. CV Mode	16:9			
	4:3			
4. Pattern	OFF			
	COLOR BAR			
5. Escape				
3. Remote Control	1. PAN/TILT Reverse	OFF		
		P		
		T		
		P+T		

	2. Remote Source	RS-422, SW (Configurable using bottom DIP switch ONLY)		
	3. Set RS-422	CAMERA ID MODE	BY MENU	
		CAMERA ID	1~7	
		RS-422 BAUD RATE	9600	
			19200	
			38400	
	ESCAPE	115200		
	4. Set DVIP	DVIP BAUD RATE	9600	
			19200	
			38400	
57600				
ESCAPE		115200		
5. Set IR	IR GROUP ID (Configurable using rear DIP switch ONLY)	CAM1~4		
	ESCAPE			
6. PTZ INFO. Output	ON/OFF			
7. Escape				
4. System	1. Display	P/T/Z OSD	PAN OSD	ON/OFF
			TILT OSD	ON/OFF
			ZOOM OSD	ON/OFF
			ESCAPE	
		DEBUG OSD	DEBUG IR OSD	ON/OFF
			DEBUG CAM. OSD	ON/OFF
			DEBUG RS-422 OSD	ON/OFF
			DEBUG DVIP OSD	ON/OFF
			DEBUG M_CTL OSD	ON/OFF
			DEBUG REG OSD	ON/OFF
			DEBUG FRAME NO	ON/OFF
			PWR ON CAM TEST	ON/OFF
		ESCAPE		

	2. Set Motor	PAN torque ADJ	LOW	
			+1~+5	
		TILT torque ADJ	LOW	
			+1~+5	
		PAN offset ADJ	+5.4	
			+4.5	
			+3.6	
			+2.7	
			+1.8	
			+0.9	
			0.0	
			-0.9	
			-1.8	
			-2.7	
			-3.6	
			-4.5	
		TILT offset ADJ	-5.4	
			+6.3	
			+5.4	
			+4.5	
	+3.6			
	+2.7			
	+1.8			
	+0.9			
	0.0			
	-0.9			
	3. Tally Light	ESCAPE		
		RED/GREEN		
		GREEN		
		RED		
	4. Reset All	OFF		
		YES/NO		
5. Update Software	SW VERSION	ESCAPE		
	MB CPU	V01.17i		
	MB FPGA	V017		
	MCTL CPU	V00.42		
	UPDATE ALL	YES/NO		
	ESCAPE			



		6. Escape			
<b>5. Camera Set (ADVANCE)</b>	1. Camera Name	NAME			
		DISPLAY SW	ON/OFF		
		POSITION	UPPER LEFT		
			LOWER LEFT		
			UPPER RIGHT		
	LOWER RIGHT				
	ESCAPE				
	2. Mirror	H+V			
		V			
		H			
		OFF			
	3. White Balance	MODE	AWB (AUTO)		
			AWC (ONE PUSH)		
			MWB (MANUAL)		
			3200K (INDOOR)		
			6500K (OUTDOOR)		
		4200K (FLUO)			
		SMART ATW (Enabled in AWB (AUTO) mode)	OFF		
		SMART1~3			
	MWB RED COMPONENT	0~128~255			
	MWB BLUE COMPONENT	0~128~255			
	ESCAPE				
	4. Focus	FOCUS MODE	AUTO		
			MANUAL		
		AF SENSITIVITY	LOW		
			NORMAL		
		FOCUS SPEED	1		
			2		
			3		
	4				
	ESCAPE				
	5. Iris	IRIS MODE	AUTO		
MANUAL					
Manual IRIS LEVEL		F1.6			
		F2.0			
		F2.4			
	F2.8				

		F3.4		
		F4		
		F4.8		
		F5.6		
		F6.8		
		F8		
		F9.6		
		F11		
		F14		
		CLOSE		
	ESCAPE			
	6. AGC	DAY (COLOR) AGC	AGC MODE	ON/OFF
			MANUAL GAIN	0dB~GAIN LIMIT
			GAIN LIMIT	9 dB
				12 dB
15 dB				
18 dB				
21 dB				
24 dB				
27 dB				
30 dB				
33 dB				
36 dB				
39 dB				
ESCAPE				
DNR	DNR(AT AGC ON)	ON		
		OFF		
	DNR LEVEL	0		
		1		
		2		
3				
4				
5				
ESCAPE				
7. Fog Correction	FOG CORRECTION	OFF/ON		
	ESCAPE			
8. Aperture	0~15			

	9. Vivid Effect	0~14		
	10. Pedestal Effect	0~14		
	11. Backlight Correction	OFF/ON <b>(This option is enabled after AGC is turned on)</b>		
	12. Day/Night Mode	B/W		
		COLOR		
	13. Shutter	SHUTTER SPEED	NORMAL	
			1/100	
			1/125	
			1/250	
			1/500	
		1/1000		
	ESCAPE			
14. Gamma Mode	STANDARD MODE1 (WD OFF) MODE2 (WD OFF) MODE3 (WD OFF) MODE4 (WD OFF)			
15. WD Mode	ON/OFF <b>(This option is enabled after AGC is turned on)</b>			
16. Escape				
<b>6. Escape</b>				

## 6. DIP Switch Settings

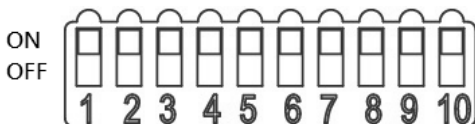

<b>DIP SW 1/2/3</b>	<b>VISCA ID</b>
ON / OFF / OFF	VISCA-ID 1
OFF / ON / OFF	VISCA-ID 2
ON / ON / OFF	VISCA-ID 3
OFF / OFF / ON	VISCA-ID 4
ON / OFF / ON	VISCA-ID 5
OFF / ON / ON	VISCA-ID 6
ON / ON / ON	VISCA-ID 7
<b>DIP SW 4</b>	<b>Remote Control Protocol</b>
ON	DVIP
OFF	RS-422
<b>DIP SW 5/6/7</b>	<b>Resolution</b>
OFF / OFF / OFF	1920x1080i60
ON / OFF / OFF	1920x1080i50
OFF / ON / OFF	1280x720p60
ON / ON / OFF	1280x720p50
OFF / OFF / ON	1920x1080p30
ON / OFF / ON	1920x1080p25
OFF / ON / ON	1920x1080p60
ON / ON / ON	1920x1080p50
<b>DIP SW 8</b>	<b>Video Mode Selection Method</b>
ON	ON = video mode selectable by DIP switch only
OFF	OFF = video mode selectable by menu
<b>DIP SW 9/10</b>	<b>Camera Select Function (IR Remote Control) – Camera ID Assignment</b>
OFF / OFF	CAM 1
ON / OFF	CAM 2
OFF / ON	CAM 3
ON / ON	CAM 4

## 7. RS-422 Control Protocol

### 7.1 PIN Descriptions

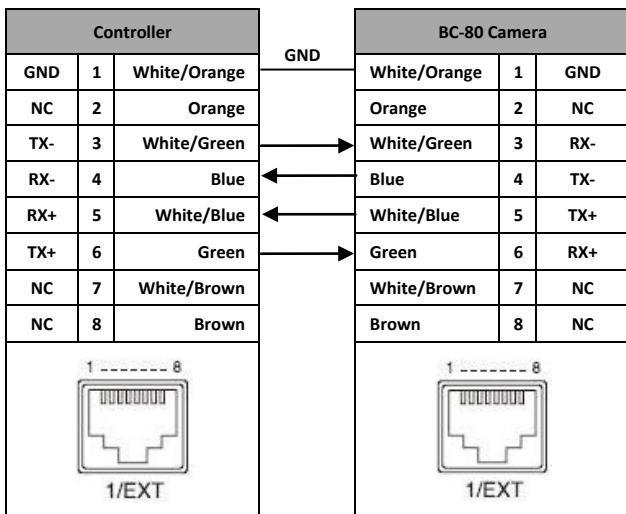

## 7.2 Control Operation Guide

### 7.2.1 Overview of VISCA

In VISCA, the side outputting commands, for example a computer, is called the controller, while the side receiving the commands, such as the BC-80, is called the peripheral device. The BC-80 serves as a peripheral device in VISCA. In VISCA, up to seven peripheral devices like the BRC-300/P can be connected to one controller using communication conforming to the RS-232C/RS-422 standard. The parameters of RS-232C/RS-422 are as follows.

- Communication speed: 38400 bps
- Data bits: 8
- Start bit: 1
- Stop bit: 1
- Non parity

Flow control using XON/XOFF and RTS/CTS, etc., is not supported.  
 The address of the controller is fixed at 0.  
 The addresses of peripheral devices are described as follows.

**When the address of the controller is fixed at 0**

The addresses of the peripheral devices are 1, 2, 3... in order, starting from the one nearest the controller. The address of the peripheral device is set by sending address commands during the initialization of the network.

**When the address of the controller is fixed at 1 through 7**

The addresses of the peripheral devices will be set on a pre-selected number. Within a single system, the same number can be used only once. If an address-switch number other than 0 is to be used, change the BC-80 address switch to a different number beforehand.

Each VISCA device has a VISCA IN and VISCA OUT connector.  
 Set the DTR input (the S output of the controller) of VISCA IN to H when controlling VISCA equipment from the controller.

**Fig. 1 VISCA network configuration**

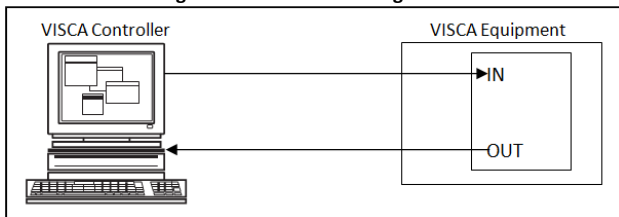

## 7.2.2 VISCA Communication Specifications

### VISCA Packet Structure

The basic unit of VISCA communication is called a packet (Fig. 2). The first byte of the packet is called the header and comprises the sender's and receiver's addresses. For example, the header of the packet sent to the BC-80 assigned address 1 from the controller (address 0) is hexadecimal 81H. The packet sent to the BC-80 assigned address 2 is 82H. In the command list, as the header is 8X, input the address of the BC-80 at X. The header of the reply packet from the BC-80 assigned address 1 is 90H. The packet from the BC-80 assigned address 2 is A0H.

Some of the commands for setting BC-80 units can be sent to all devices at one time (broadcast). In the case of broadcast, the header should be hexadecimal 88H.

When the terminator is FFH, it signifies the end of the packet.

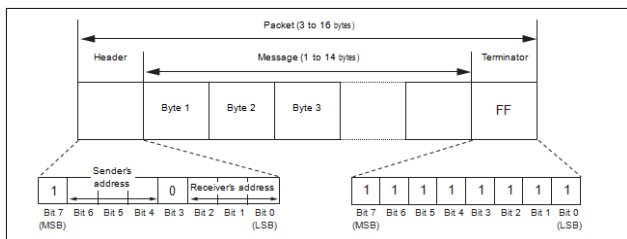

**Fig. 2 Packet structure**

### Note

Fig. 2 shows the packet structure, while Fig. 3 shows the actual waveform. Data flow will take place with the LSB first.

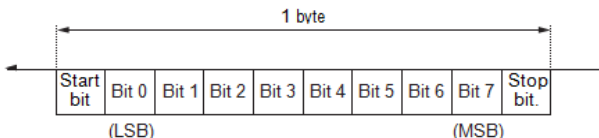

**Fig. 3 Actual waveform for 1 byte**

### Timing Chart

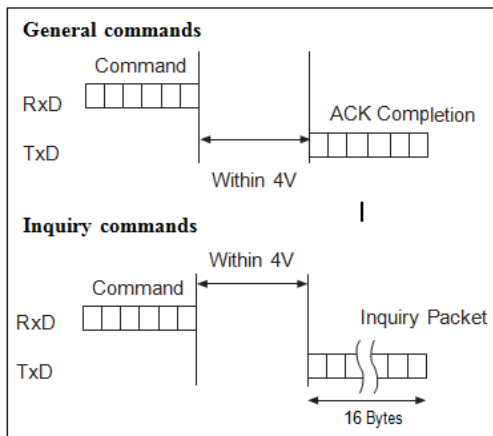

As VISCA Command processing can only be carried out one time in a Vertical cycle, it takes the maximum 1V cycle time for an ACK/Completion to be returned. If the Command ACK/Completion communication time can be cut shorter than the 1V cycle time, then every 1V cycle can receive a Command.

From this point, if 2 or more commands in a row are to be sent, wait



for the first command (for normal commands, an ACK or an error message, for query commands, an Inquiry Packet) to be carried out before sending the next one.

### Command and inquiry

- **Command**

Sends operational commands to the BC-80.

- **Inquiry**

Used for inquiring about the current state of the BC-80.

	Command Packet	Note
Inquiry	8X QQ RR ... FF	QQ <sup>1)</sup> = Command/Inquiry RR <sup>2)</sup> = category code
<sup>1)</sup> QQ = 01 (Command), 09 (Inquiry) <sup>2)</sup> RR = 00 (Interface), 04 (camera 1), 06 (Pan/Tilter)		

X = 1 to 7: BC-80 address

### Responses for commands and inquiries

- **ACK message**

Returned by the BC-80 when it receives a command. No ACK message is returned for inquiries.

- **Completion message**

Returned by the BC-80 when execution of commands or inquiries is completed. In the case of inquiry commands, it will contain reply data for the inquiry after the 3<sup>rd</sup> byte of the packet. If the ACK message is omitted, the socket number will contain a 0.

	Reply Packet	Note
Ack	X0 4Y FF	Y = socket number
Completion (Commands)	X0 5Y FF	Y = socket number
Completion (Inquiries)	X0 5Y ... FF	Y = socket number
X = 9 to F: BC-80 address + 8		

- **Error message**

When a command or inquiry command could not be executed or failed, an error message is returned.

<b>Error Packet</b>	<b>Description</b>
X0 6Y 01 FF	Message length error
X0 6Y 02 FF	Syntax error
X0 6Y 03 FF	Command buffer full
X0 6Y 04 FF	Command cancelled
X0 6Y 05 FF	No socket (to be cancelled)
X0 6Y 41 FF	Command not executable
X = 9 to F: BC-80 address + 8, Y = socket number Socket number = 1 (normal)	

### **Socket number**

When command messages are sent to the BC-80, it is normal to send the next command message after waiting for the completion message or error message to return.

As the completion message or error message also has a socket number, it indicates which command has ended.

The ACK message is not returned for these commands and inquiries, and only the completion message of socket number 0 is returned.

### **7.2.3 VISCA Device Setting Command**

Before starting control of the BC-80, be sure to send the Address command and the IF\_Clear command using the broadcast function.

#### **VISCA interface command**

- **IF\_Clear**

Clears the command buffers in the BC-80 and cancels the command currently being executed.

	Command Packet	Reply Packet	Note
IF_Clear	8X 01 00 01 FF	X0 50 FF	
IF_Clear (broadcast)	88 01 00 01 FF	88 01 00 01 FF	
X = 1 to 7: BC-80 address (For inquiry packet)			
X = 9 to F: BC-80 address + 8 (For reply packet)			

### 7.2.4 VISCA Command/ACK Protocol

Command	Command Message	Reply Message	Comments
General Command	81 01 04 38 02 FF (Example)	90 41 FF (ACK)+90 51 FF (Completion) 90 42 FF 90 52 FF	Returns ACK when a command has been accepted, and Completion when a command has been executed.
	81 01 04 38 FF (Example)	90 60 02 FF (Syntax Error)	Accepted a command which is not supported or a command lacking parameters
	81 01 04 38 02 FF (Example)	90 60 03 FF (Command Buffer Full)	There are two commands currently being executed, and the command could not be accepted.
	81 01 04 08 02 FF (Example)	90 61 41 FF (Command Not Executable) 90 62 41 FF	Could not execute the command in the current mode.
Inquiry Command	81 09 04 38 FF (Example)	90 50 02 FF (Completion)	ACK is not returned for the inquiry command.

	81 09 05 38 FF (Example)	90 60 02 FF (Syntax Error)	Accepted an incompatible command.
Address Set	88 30 01 FF	88 30 02 FF	Returned the device address to +1.*
IF_Clear (Broadcast)	88 01 00 01 FF	88 01 00 01 FF	Returned the same command.
IF_Clear (For x)	8x 01 00 01 FF	z0 50 FF (Completion)	ACK is not returned for this command.

\*When the address-switch is fixed at 0, the value x in 88 30 0x FF will be indeterminate.

Do not transmit the command (except Address Set, IF\_Clear, CAM\_POWER), when menu panel shows on the screen. In that case, clear the menu panel first using CAM\_Menu Command, and then proceed.

## 7.2.5 VISCA Camera-Issued Messages

### ACK/Completion Messages

Command	Command Message	Comments
ACK	z0 4y FF (y: Socket No.)	Returned when the command is accepted
Completion	z0 5y FF (y: Socket No.)	Returned when the command has been executed

z = Device address + 8

### Error Messages

Command	Command Messages	Comments
Syntax Error	z0 60 02 FF	Returned when the command format is different or when a command with illegal

		command parameters is accepted.
Command Buffer Full	z0 60 03 FF	Indicates that two sockets are already being used (executing two commands) and the command could not be accepted when received.
No Socket	z0 6y 05 FF (y: Socket No.)	Returned when no command is executed in a socket specified by the cancel command, or when an invalid socket number is specified.
Command Not Executable	z0 6y 41 FF (y: Socket No.)	Returned when a command cannot be executed due to current conditions. For example, when commands controlling the focus manually are received during auto focus.

## 7.2.6 BC-80 Commands

### BC-80 Command List

Command Set	Command	Command Packet	Comments
AddressSet	Broadcast	88 30 01 FF	Address Set
IF_Clear	Broadcast	88 01 00 01 FF	I/F Clear
CAM_Power	On	8x 01 04 00 02 FF	Power On/Off
	Off	8x 01 04 00 03 FF	
CAM_ZOOM	Stop	8x 01 04 07 00 FF	

	Tele (Standard)	8x 01 04 07 02 FF	
	Wide (Standard)	8x 01 04 07 03 FF	
	Tele (Variable)	8x 01 04 07 2p FF	p (=0: Slow to 7:Fast)
	Wide (Variable)	8x 01 04 07 3p FF	p (=0: Slow to 7:Fast)
	Direct	8x 01 04 47 0p 0q 0r 0s FF	pqrs: Zoom Position*
CAM_Focus	Stop	8x 01 04 08 00 FF	
	Far (Standard)	8x 01 04 08 02 FF	
	Near (Standard)	8x 01 04 08 03 FF	
	Direct	8x 01 04 48 0p 0q 0r 0s FF	pqrs: Focus Position*
	Auto Focus	8x 01 04 38 02 FF	AF ON/OFF
	Manual Focus	8x 01 04 38 03 FF	
	One Push Trigger	8x 01 04 18 01 FF	One Push AF Trigger
CAM_WB	Auto	8x 01 04 35 00 FF	Normal Auto
	Indoor	8x 01 04 35 01 FF	Indoor Mode
	Outdoor	8x 01 04 35 02 FF	Outdoor Mode
	One Push WB	8x 01 04 35 03 FF	One Push WB Mode
	Manual	8x 01 04	Manual

		35 05 FF	Control Mode
	One Push Trigger	8x 01 04 10 05 FF	One Push WB Trigger
CAM_RGain	Reset	8x 01 04 03 00 FF	Default R Gain setting
	Up	8x 01 04 03 02 FF	
	Down	8x 01 04 03 03 FF	
	Direct	8x 01 04 43 00 00 0p 0q FF	R Gain Direct pq (=00 to FF)
CAM_BGain	Reset	8x 01 04 04 00 FF	Default B Gain setting
	Up	8x 01 04 04 02 FF	
	Down	8x 01 04 04 03 FF	
	Direct	8x 01 04 44 00 00 0p 0q FF	B Gain Direct pq (=00 to FF)
CAM_AE	Full Auto	8x 01 04 39 00 FF	Automatic exposure mode
	Manual	8x 01 04 39 03 FF	Manual control mode
	Shutter Priority	8x 01 04 39 0A FF	Shutter priority automatic exposure mode

	Iris Priority	8x 01 04 39 0B FF	Iris priority automatic exposure mode
	Bright	8x 01 04 39 0D FF	Bright mode (Manual)
CAM_Shutter	Reset	8x 01 04 0A 00 FF	Default Shutter setting
	Up	8x 01 04 0A 02 FF	
	Down	8x 01 04 0A 03 FF	
CAM_Iris	Reset	8x 01 04 0B 00 FF	Default Iris Setting
	Up	8x 01 04 0B 02 FF	
	Down	8x 01 04 0B 03 FF	
	Direct	8x 01 04 4B 00 00 0p 0q FF	pq: Iris Position*
CAM_Gain	Reset	8x 01 04 0C 00 FF	Default Gain setting
	Up	8x 01 04 0C 02 FF	
	Down	8x 01 04 0C 03 FF	
	Direct	8x 01 04 4C 00 00 0p 0q FF	pq: Iris Position*
CAM_Backlight	On	8x 01 04 33 02 FF	Back Light ON/OFF



	Off	8x 01 04 33 03 FF	
PTZ_Position	Reset	8x 01 04 3F 00 0p FF	Memory Number p (=0 to 50)
	Set	8x 01 04 3F 01 0p FF	Memory Number p (=0 to 50)
	Recall	8x 01 04 3F 02 0p FF	Memory Number p (=0 to 50)
CAM_Menu	On	8x 01 06 06 02 FF	Menu ON
	Off	8x 01 06 06 03 FF	Menu OFF
Pan-tilt Drive	Up	8x 01 06 01 VV WW 03 01 FF	PanSpeed VV (=01:Slow to 18h:Fast) TiltSpeed WW (=01:Slow to 18h:Fast)
	Down	8x 01 06 01 VV WW 03 02 FF	
	Left	8x 01 06 01 VV WW 01 03 FF	
	Right	8x 01 06 01 VV WW 02 03 FF	
	UpLeft	8x 01 06 01 VV WW 01 01 FF	
	UpRight	8x 01 06 01 VV WW 02 01 FF	
	DownLeft	8x 01 06 01 VV WW	

		01 02 FF	
	DownRight	8x 01 06 01 VV WW 02 02 FF	
	Stop	8x 01 06 01 VV WW 03 03 FF	
	AbsolutePosition	8x 01 06 02 VV 00 0Y 0Y 0Y 0Y 0Y 0Z 0Z 0Z 0Z FF	Speed VV (=01: Slow to 18h:Fast) YYYYY: Pan Position* ZZZZ: Tilt Position*
	RelativePosition	8x 01 06 03 VV 00 0Y 0Y 0Y 0Y 0Y 0Z 0Z 0Z 0Z FF	Speed VV (=01: Slow to 18h:Fast) YYYYY: Pan Position* ZZZZ: Tilt Position*
	Home	8x 01 06 04 FF	
	Reset	8x 01 06 05 FF	
CAM_ImgFlip	On	8x 01 04 66 02 FF	
	Off	8x 01 04 66 03 FF	
Cam_PanReverse	On	8x 01 7E 01 06 00 01 FF	
	Off	8x 01 7E	

		01 06 00 00 FF	
Cam_TiltReverse	On	8x 01 7E 01 09 00 01 FF	
	Off	8x 01 7E 01 09 00 00 FF	
Cmd_Tally	On	8x 01 7E 01 0A 00 02 FF	When Power is on, return to off.
	Off	8x 01 7E 01 0A 00 03 FF	
Cmd_PT_M_Speed	Preset PT Speed	8x 01 7E 01 0B 0p 0q FF	p: Memory number (=0 to 50) q: Speed (=1 to 18:fast)

\*See the section under VISCA Command Setting Values

### BC-80 Inquiry Command List

Inquiry Command	Command Packet	Inquiry Packet	Comments
CAM_PowerInq	8x 09 04 00 FF	y0 50 02 FF	On
		y0 50 03 FF	Off (Standby)
CAM_ZoomPosInq	8x 09 04 47 FF	y0 50 0p 0q 0r 0s FF	pqrs: Zoom Position
CAM_FocusModel nq	8x 09 04 38 FF	y0 50 02 FF	Auto Focus

		y0 50 03 FF	Manual Focus
CAM_FocusPosInq	8x 09 04 48 FF	y0 50 0p 0q 0r 0s FF	pqrs: Focus Position
CAM_WBModelInq	8x 09 04 35 FF	y0 50 00 FF	Auto
		y0 50 01 FF	Indoor
		y0 50 02 FF	Outdoor
		y0 50 03 FF	One Push WB
		y0 50 05 FF	Manual
CAM_RGainInq	8x 09 04 43 FF	y0 50 00 00 0p 0q FF	pq: R Gain
CAM_BGainInq	8x 09 04 44 FF	y0 50 00 00 0p 0q FF	pq: B Gain
CAM_AEModelInq	8x 09 04 39 FF	y0 50 00 FF	Full Auto
		y0 50 03 FF	Manual
		y0 50 0A FF	Shutter Priority
		y0 50 0B FF	Iris Priority
CAM_ShutterPosInq	8x 09 04 4A FF	y0 50 00 00 0p 0q FF	pq: Shutter Position
CAM_IrisPosInq	8x 09 04 4B FF	y0 50 00 00 0p 0q FF	pq: Iris Position

CAM_GainPosInq	8x 09 04 4C FF	y0 50 00 00 0p 0q FF	pq: Gain Position
CAM_BackLightModelInq	8x 09 04 33 FF	y0 50 02 FF	On
		y0 50 03 FF	Off
CAM_MemoryInq	8x 09 04 3F FF	y0 50 pp FF	pp: Memory number for PTZ last operated*
CAM_MENUInq	8x 09 06 06 FF	y0 50 02 FF	On
		y0 50 03 FF	Off
CAM_VersionInq	8x 09 00 02 FF	y0 50 00 01 mn pq rs tu vw FF	mnpq: Model Code (04xx) rstu: ROM version vw: Socket Number (02)
CAM_ImgFlipInq	8x 09 04 66 FF	y0 50 02 FF	On
		y0 50 03 FF	Off
CAM_PanReverseInq	8x 09 7E 01 06 FF	y0 50 01 FF	On
		y0 50 00 FF	Off
CAM_TiltReverseInq	8x 09 7E 01 09 FF	y0 50 01 FF	On

		y0 50 00 FF	Off
PanTilt_Status	8x 09 06 10 FF	y0 50 pq rs FF	pqrs: PanTilt Status
PanTilt_Max_Speed	8x 09 06 11 FF	y0 50 pq rs FF	pq: Pan Max Speed, rs: Tilt Max Speed
PanTilt_Position	8x 09 06 12 FF	y0 50 0p 0q 0r 0s 0t 0u 0v 0w 0x FF	pqrst: Pan Position uvwxy: Tilt Position
Tally	8x 09 7E 01 0A FF	y0 50 02 FF	On
		y0 50 03 FF	Off
PanTilt_Memory_Speed	8x 09 7E 01 0B 0p FF	y0 50 0q FF	p: Preset No. 0 - 50, qq: Speed 1 - 18 (h)

\*See the section under VISCA Command Setting Values

## 8. DVIP Control Operation Guide

### 8.1 Physical Layer

- Control Interface: Ethernet
- Communication Speed: 10/100Mbps
- Control Protocol: TCP/IP

### 8.2 General Connection Information

- By default, the DVIP is configured to operate in DHCP mode. User is allowed to re-configure to static IP address.
- TCP/IP Control port numbers  
TCP port: 5002  
UDP port: 5002

### 8.3 Packet Data

#### Control Command Packet (TCP)

Byte (8 bits)	Descriptions
0	Packet Length High Byte
1	Packet Length Low Byte
2	Command_Data [0]
...	...
513	Command_Data [511]

#### Broadcast Packet

Byte (8 bits)	Descriptions
0	Packet Length High Byte
1	Packet Length Low Byte
2	0x80
3	Command
4	Parameter 1
...	...
251	Parameter 248

## Broadcast Command List – Request TCP/IP information

Command Issue to DVIP device

<b>Request TCP/IP information, include DHCP mode, DHCP Host name, IP address, Netmask, MAC address, Gateway, Primary DNS, Secondary DNS</b>	
Command	0x00
Parameter 1	0x45
Parameter 2	0x54
Parameter 3	0x48
Parameter 4	0x5F
Parameter 5	0x52
Parameter 6	0x45
Parameter 7	0x51

Command Return from DVIP device

<b>Length</b>	<b>Descriptions</b>
1 Byte	Data Length High Byte
1 Byte	Data Length Low Byte
1 Byte	0x80
1 Byte	0x00
1 Byte	DHCP; 0: Disable; 1: Enable
16 Bytes	DHCP Host name (15 bytes max) + Null (0x00) terminated
6 Bytes	MAC Address
4 Bytes	IP Address
4 Bytes	Netmask
4 Bytes	Gateway
4 Bytes	Primary DNS address
4 Bytes	Secondary DNS address



## Broadcast Command List – Request specific DVIP device firmware revision

Command Issue to DVIP device

<b>Request DVIP Firmware Revision</b>	
Command	0x01
Parameter 1	DVIP MAC address [0]
Parameter 2	DVIP MAC address [1]
Parameter 3	DVIP MAC address [2]
Parameter 4	DVIP MAC address [3]
Parameter 5	DVIP MAC address [4]
Parameter 6	DVIP MAC address [5]
Parameter 7	0x46
Parameter 8	0x57
Parameter 9	0x56
Parameter 10	0x45
Parameter 11	0x52
Parameter 12	0x5F
Parameter 13	0x52
Parameter 14	0x45
Parameter 15	0x51

Command Return from DVIP device

<b>Length</b>	<b>Descriptions</b>
1 Byte	0x00 (Data Length High Byte)
1 Byte	0x06 (Data Length Low Byte)
1 Byte	0x80
1 Byte	0x01
1 Byte	Firmware Revision Major Number
1 Byte	Firmware Revision Minor Number

## Broadcast Command List – Set DHCP Mode

Command Issue to DVIP device

Set DHCP Mode	
Command	0x02
Parameter 1	DVIP MAC address [0]
Parameter 2	DVIP MAC address [1]
Parameter 3	DVIP MAC address [2]
Parameter 4	DVIP MAC address [3]
Parameter 5	DVIP MAC address [4]
Parameter 6	DVIP MAC address [5]
Parameter 7	0x53
Parameter 8	0x45
Parameter 9	0x54
Parameter 10	0x5F
Parameter 11	0x44
Parameter 12	0x48
Parameter 13	0x43
Parameter 14	0x50
Parameter 15	0x4D
Parameter 16	0x4F
Parameter 17	0x44
Parameter 18	0x45
Parameter 19	0x00: Disable; 0x01: Enable

Command Return from DVIP device

Length	Descriptions
1 Byte	0x00 (Data Length High Byte)
1 Byte	0x06 (Data Length Low Byte)
1 Byte	0x80
1 Byte	0x02
1 Byte	0x06 (ACK) or 0x15 (NACK)

## Broadcast Command List – Set IP Address

Command Issue to DVIP device

Set IP Address	
Command	0x03
Parameter 1	DVIP MAC address [0]
Parameter 2	DVIP MAC address [1]
Parameter 3	DVIP MAC address [2]
Parameter 4	DVIP MAC address [3]
Parameter 5	DVIP MAC address [4]
Parameter 6	DVIP MAC address [5]
Parameter 7	0x53
Parameter 8	0x45
Parameter 9	0x54
Parameter 10	0x5F
Parameter 11	0x49
Parameter 12	0x50
Parameter 13	0x41
Parameter 14	0x44
Parameter 15	0x52
Parameter 16	IP_Address [0]
Parameter 17	IP_Address [1]
Parameter 18	IP_Address [2]
Parameter 19	IP_Address [3]
Parameter 20	Gateway [0]
Parameter 21	Gateway [1]
Parameter 22	Gateway [2]
Parameter 23	Gateway [3]

Command Return from DVIP device

Length	Descriptions
1 Byte	0x00 (Data Length High Byte)
1 Byte	0x06 (Data Length Low Byte)
1 Byte	0x80
1 Byte	0x03

1 Byte	0x06 (ACK) or 0x15 (NACK)
--------	---------------------------

### Broadcast Command List – Reset to Factory Default

Command Issue to DVIP device

Reset to Factory Default	
Command	0x04
Parameter 1	DVIP MAC address [0]
Parameter 2	DVIP MAC address [1]
Parameter 3	DVIP MAC address [2]
Parameter 4	DVIP MAC address [3]
Parameter 5	DVIP MAC address [4]
Parameter 6	DVIP MAC address [5]
Parameter 7	0x52
Parameter 8	0x45
Parameter 9	0x53
Parameter 10	0x45
Parameter 11	0x54

Command Return from DVIP device

Length	Descriptions
1 Byte	0x00 (Data Length High Byte)
1 Byte	0x06 (Data Length Low Byte)
1 Byte	0x80
1 Byte	0x04
1 Byte	0x06 (ACK) or 0x15 (NACK)

### Broadcast Command List – Get Device Model Number

Command Issue to DVIP device

Get Device Model Number	
Command	0x05
Parameter 1	DVIP MAC address [0]
Parameter 2	DVIP MAC address [1]
Parameter 3	DVIP MAC address [2]
Parameter 4	DVIP MAC address [3]

Parameter 5	DVIP MAC address [4]
Parameter 6	DVIP MAC address [5]
Parameter 7	0x47
Parameter 8	0x45
Parameter 9	0x54
Parameter 10	0x5F
Parameter 11	0x4D
Parameter 12	0x4F
Parameter 13	0x44
Parameter 14	0x45
Parameter 15	0x4C
Parameter 16	0x5F
Parameter 17	0x4E
Parameter 18	0x41
Parameter 19	0x4D
Parameter 20	0x45

#### Command Return from DVIP device

Length	Descriptions
1 Byte	0x00 (Data Length High Byte)
1 Byte	0x06 (Data Length Low Byte)
1 Byte	0x80
1 Byte	0x04
16 Bytes	Device Model Number is 16 Bytes maximum; use null padding (0x00) if it is less than 16 bytes.

#### UDP Packet

Byte (8 bits)	Descriptions
0	Packet Length High Byte
1	Packet Length Low Byte
2	0x81
3	Command
4 ... 251	Parameter 1 ... Parameter 248

## UDP Command List – Request TCP/IP information

Command Issue to DVIP device

<b>Request TCP/IP information, include DHCP mode, DHCP Host name, IP address, Netmask, MAC address, Gateway, Primary DNS, Secondary DNS</b>	
Command	0x00
Parameter 1	0x45
Parameter 2	0x54
Parameter 3	0x48
Parameter 4	0x5F
Parameter 5	0x52
Parameter 6	0x45
Parameter 7	0x51

Command Return from DVIP device

<b>Length</b>	<b>Descriptions</b>
1 Byte	Data Length High Byte
1 Byte	Data Length Low Byte
1 Byte	0x80
1 Byte	0x00
1 Byte	DHCP; 0: Disable; 1: Enable
16 Bytes	DHCP Host name (15 bytes max) + Null (0x00) terminated
6 Bytes	MAC Address
4 Bytes	IP Address
4 Bytes	Netmask
4 Bytes	Gateway
4 Bytes	Primary DNS address
4 Bytes	Secondary DNS address

## UDP Command List – Request specific DVIP device firmware revision

Command Issue to DVIP device

<b>Request DVIP Firmware Revision</b>	
Command	0x01

Parameter 1	0x46
Parameter 2	0x57
Parameter 3	0x56
Parameter 4	0x45
Parameter 5	0x52
Parameter 6	0x5F
Parameter 7	0x52
Parameter 8	0x45
Parameter 9	0x51

#### Command Return from DVIP device

Length	Descriptions
1 Byte	0x00 (Data Length High Byte)
1 Byte	0x06 (Data Length Low Byte)
1 Byte	0x80
1 Byte	0x01
1 Byte	Firmware Revision Major Number
1 Byte	Firmware Revision Minor Number

#### UDP Command List – Set DHCP Mode

##### Command Issue to DVIP device

Set DHCP Mode	
Command	0x02
Parameter 1	0x53
Parameter 2	0x45
Parameter 3	0x54
Parameter 4	0x5F
Parameter 5	0x44
Parameter 6	0x48
Parameter 7	0x43
Parameter 8	0x50
Parameter 9	0x4D
Parameter 10	0x4F
Parameter 11	0x44

Parameter 12	0x45
Parameter 13	0x00: Disable; 0x01: Enable

Command Return from DVIP device

Length	Descriptions
1 Byte	0x00 (Data Length High Byte)
1 Byte	0x06 (Data Length Low Byte)
1 Byte	0x81
1 Byte	0x02
1 Byte	0x06 (ACK) or 0x15 (NACK)

### UDP Command List – Set IP Address & Gateway Address

Command Issue to DVIP device

Set IP Address	
Command	0x03
Parameter 1	0x53
Parameter 2	0x45
Parameter 3	0x54
Parameter 4	0x5F
Parameter 5	0x49
Parameter 6	0x50
Parameter 7	0x41
Parameter 8	0x44
Parameter 9	0x52
Parameter 10	IP_Address [0]
Parameter 11	IP_Address [1]
Parameter 12	IP_Address [2]
Parameter 13	IP_Address [3]
Parameter 14	Gateway [0]
Parameter 15	Gateway [1]
Parameter 16	Gateway [2]
Parameter 17	Gateway [3]



#### Command Return from DVIP device

Length	Descriptions
1 Byte	0x00 (Data Length High Byte)
1 Byte	0x05 (Data Length Low Byte)
1 Byte	0x81
1 Byte	0x03
1 Byte	0x06 (ACK) or 0x15 (NACK)

#### UDP Command List – Reset to Factory Default

##### Command Issue to DVIP device

Reset to Factory Default	
Command	0x04
Parameter 1	0x52
Parameter 2	0x45
Parameter 3	0x53
Parameter 4	0x45
Parameter 5	0x54

#### Command Return from DVIP device

Length	Descriptions
1 Byte	0x00 (Data Length High Byte)
1 Byte	0x06 (Data Length Low Byte)
1 Byte	0x81
1 Byte	0x04
1 Byte	0x06 (ACK) or 0x15 (NACK)

#### UDP Command List – Set DHCP Host Name

##### Command Issue to DVIP device

Set DHCP Host Name	
Command	0x09
Parameter 1	0x53
Parameter 2	0x45
Parameter 3	0x54
Parameter 4	0x5F

Parameter 5	0x44
Parameter 6	0x48
Parameter 7	0x43
Parameter 8	0x50
Parameter 9	0x4E
Parameter 10	0x41
Parameter 11	0x4D
Parameter 12	0x45
Parameter 13...	Name (ASCII), 15 bytes Max.
Parameter	Null (0x00) terminated

#### Command Return from DVIP device

Length	Descriptions
1 Byte	0x00 (Data Length High Byte)
1 Byte	0x05 (Data Length Low Byte)
1 Byte	0x81
1 Byte	0x09
1 Byte	0x06 (ACK) or 0x15 (NACK)

#### UDP Command List – Set Netmask

##### Command Issue to DVIP device

Set Netmask	
Command	0x0B
Parameter 1	0x53
Parameter 2	0x45
Parameter 3	0x54
Parameter 4	0x5F
Parameter 5	0x4E
Parameter 6	0x45
Parameter 7	0x54
Parameter 8	0x4D
Parameter 9	0x41
Parameter 10	0x53

Parameter 11	0x4B
Parameter 12	Net_Mask [0]
Parameter 13	Net_Mask [1]
Parameter 14	Net_Mask [2]
Parameter 15	Net_Mask [3]

#### Command Return from DVIP device

Length	Descriptions
1 Byte	0x00 (Data Length High Byte)
1 Byte	0x05 (Data Length Low Byte)
1 Byte	0x81
1 Byte	0x0B
1 Byte	0x06 (ACK) or 0x15 (NACK)

#### UDP Command List – Set Gateway Address

##### Command Issue to DVIP device

Set Gateway Address	
Command	0x0C
Parameter 1	0x53
Parameter 2	0x45
Parameter 3	0x54
Parameter 4	0x5F
Parameter 5	0x47
Parameter 6	0x41
Parameter 7	0x54
Parameter 8	0x45
Parameter 9	0x57
Parameter 10	0x41
Parameter 11	0x59
Parameter 12	Gateway [0]
Parameter 13	Gateway [1]
Parameter 14	Gateway [2]
Parameter 15	Gateway [3]

#### Command Return from DVIP device

Length	Descriptions
1 Byte	0x00 (Data Length High Byte)
1 Byte	0x05 (Data Length Low Byte)
1 Byte	0x81
1 Byte	0x0C
1 Byte	0x06 (ACK) or 0x15 (NACK)

#### UDP Command List – Set Primary DNS Address

##### Command Issue to DVIP device

Set Gateway Address	
Command	0x0D
Parameter 1	0x53
Parameter 2	0x45
Parameter 3	0x54
Parameter 4	0x5F
Parameter 5	0x50
Parameter 6	0x52
Parameter 7	0x49
Parameter 8	0x44
Parameter 9	0x4E
Parameter 10	0x53
Parameter 11	Primary_DNS_IP [0]
Parameter 12	Primary_DNS_IP [1]
Parameter 13	Primary_DNS_IP [2]
Parameter 14	Primary_DNS_IP [3]

#### Command Return from DVIP device

Length	Descriptions
1 Byte	0x00 (Data Length High Byte)
1 Byte	0x05 (Data Length Low Byte)
1 Byte	0x81
1 Byte	0x0D
1 Byte	0x06 (ACK) or 0x15 (NACK)

## UDP Command List – Set Secondary DNS Address

Command Issue to DVIP device

Set Gateway Address	
Command	0x0E
Parameter 1	0x53
Parameter 2	0x45
Parameter 3	0x54
Parameter 4	0x5F
Parameter 5	0x53
Parameter 6	0x45
Parameter 7	0x43
Parameter 8	0x44
Parameter 9	0x4E
Parameter 10	0x53
Parameter 11	Secondary_DNS_IP [0]
Parameter 12	Secondary_DNS_IP [1]
Parameter 13	Secondary_DNS_IP [2]
Parameter 14	Secondary_DNS_IP [3]

Command Return from DVIP device

Length	Descriptions
1 Byte	0x00 (Data Length High Byte)
1 Byte	0x05 (Data Length Low Byte)
1 Byte	0x81
1 Byte	0x0E
1 Byte	0x06 (ACK) or 0x15 (NACK)

## UDP Command List – Initial DVIP Configuration

Command Issue to DVIP device

Initial DVIP Configuration	
Command	0x0F
Parameter 1	0x49
Parameter 2	0x4E

Parameter 3	0x49
Parameter 4	0x54
Parameter 5	0x5F
Parameter 6	0x45
Parameter 7	0x32
Parameter 8	0x50
Parameter 9	DHCP_Mode
Parameter 10	DHCP_Host_Name [0-14] (ASCII), 15 Bytes Max.
Parameter N	Null (0x00)
Parameter N+1	MAC_Address [0-3]
Parameter N+5	IP_Address [0-3]
Parameter N+9	Gateway_IP [0-3]
Parameter N+13	Net_Mask [0-3]
Parameter N+17	Primary_DNS_IP [0-3]
Parameter N+21	Secondary_DNS_IP [0-3]

Command Return from DVIP device

Length	Descriptions
1 Byte	0x00 (Data Length High Byte)
1 Byte	0x05 (Data Length Low Byte)
1 Byte	0x81
1 Byte	0x0F
1 Byte	0x06 (ACK) or 0x15 (NACK)

## 9. Firmware Upgrade

- 1) Copy MB CPU and MB FPGA image files into the root directory of a USB hard drive (<16 GB) and insert it into the USB Upgrade port (You may use a USB extension cord).
- 2) Open the OSD menu using IR remote control by pressing the MENU button.
- 3) Browse to  
=> 4: SYSYEM  
    => 4: UPDATE SOFTWARE  
        => 4: UPDATE ALL  
            =>YES  
                => ENTER
- 4) Wait for another five minutes until the following lines appear on the screen
  - Updated FPGA =>OK
  - Updated MCPU =>OKThe OSD will flash "Write OK/Power ON Again".  
**Note: it takes approximately 5-7 minutes to complete the update.**
- 5) Turn off the device by unplugging the power cord. Plug the power cord back into the socket and then turn on the device again.
- 6) FW Update is complete.

## 10. Dimensions

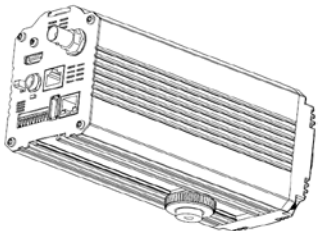
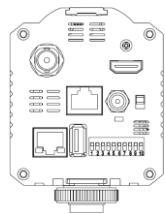
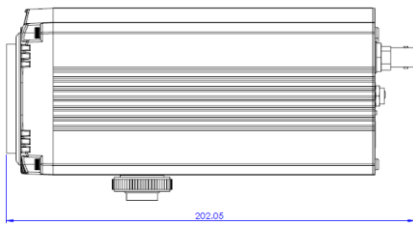
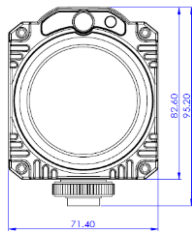
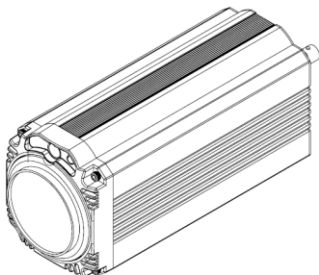

All measurements in millimeters (mm)



## 11. Specifications

<b>Video</b>	
<b>Image Pickup Element</b>	1/2.8" type Exmor CMOS sensor
<b>Effective Picture Elements</b>	Approx. 2.38 Mega pixels
<b>Signal System</b>	HDMI & SDI: 1080p/60/59.94/50/30/29.97/25 1080i/60/59.94/50/30/29.97/25 720p/60/59.94/50/30/29.97/25
<b>S/N Ratio</b>	50 dB
<b>Min. Illumination</b>	50%, High Sensitivity Mode Color : 0.75 lx (F1.8, AGC ON, 1/30 sec)
<b>Electric Shutter</b>	1/1 to 1/10,000 sec
<b>Gamma Control</b>	Off / Normal / Standard Mode 1-4
<b>Iris Control</b>	Auto / Manual
<b>Digital Noise Reductions</b>	0 – 5
<b>On-Screen Display (OSD)</b>	English
<b>White Balance</b>	AWB / MWB / One push WB / Outdoor / Indoor / Fluorescent
<b>AGC / Gain Control</b>	Auto / Manual (0 to 28 step) Max. Gain Limit (6 to 28 step)
<b>Zoom Ratio</b>	30x Optical Zoom
<b>Mirror</b>	OFF / Horizontal / Vertical / H+V
<b>Color Bar</b>	On / Off (Full Bar)
<b>Focus Mode</b>	Auto / Manual
<b>Day &amp; Night (IR)</b>	Auto / Color / BW
<b>Lens</b>	
<b>Lens Type</b>	30x Optical Zoom
<b>Focal Length</b>	F=4.3 mm (WIDE) to 129 mm (TELE) F1.6 to F4.7
<b>Angle of View (Horizontal)</b>	Approx. 63.7 degrees (WIDE END) / 2.3 degrees (TELE END)

<b>Video Output</b>	
<b>Video Output</b>	HDMI (V1.3) x 1 HD-SD-SDI x 1
<b>Control</b>	
<b>Protocol</b>	VISCA / DVIP Protocol
<b>Remote Control</b>	RS-422 & DVIP by RJ-45 interface
<b>F/W Update</b>	USB 2.0
<b>IR Control</b>	One IR controller
<b>Others</b>	
<b>Operating Temperature</b>	0°C ~ 50°C
<b>Storage Temperature</b>	- 10°C ~ 60°C
<b>Operating Humidity:</b>	10 % to 80 % (non-condensing)

# Service & Support

It is our goal to make your products ownership a satisfying experience. Our supporting staff is available to assist you in setting up and operating your system. Please refer to our web site [www.datavideo.com](http://www.datavideo.com) for answers to common questions, support requests or contact your local office below.

## **Datavideo Taiwan**

Datavideo Technologies Co. Ltd  
10F, No. 176, Jian 1st Rd., Chung Ho  
District, New Taipei City 235, Taiwan,  
R.O.C.

Tel: +886-2-8227-2888

Fax: +886-2-8227-2777

E-mail: [service@datavideo.com.tw](mailto:service@datavideo.com.tw)

## **Datavideo Europe**

Datavideo Technologies Europe BV  
Floridaadreef 106  
3585 AM Utrecht,  
The Netherlands

Tel: +31-30-261-96-56

Fax: +31-30-261-96-57

E-mail: [info@datavideo.nl](mailto:info@datavideo.nl)

## **Datavideo United Kingdom**

Datavideo UK Limited  
Brookfield House, Brookfield Industri  
Estate, Peakdale Road, Glossop,  
Derbyshire, SK13 6LQ

Tel: +44-1457 851 000

Fax: +44-1457 850 964

E-mail: [sales@datavideo.co.uk](mailto:sales@datavideo.co.uk)

## **Datavideo USA**

Datavideo Corporation  
7048 Elmer Avenue,  
Whittier, CA 90602,  
U.S.A.

Tel: +1-562-696 2324

Fax: +1-562-698 6930

E-mail: [sales@datavideo.us](mailto:sales@datavideo.us)

## **Datavideo China**

Datavideo Technologies China Co  
601, Building 10, No. 1226,  
Rd. Jiangchang,  
Jingan District, Shanghai

Tel: +86 21-5603 6599

Fax: +86 21-5603 6770

E-mail: [service@datavideo.cn](mailto:service@datavideo.cn)

## **Datavideo Singapore**

Datavideo Technologies (S) PTE Ltd  
No. 176 Paya Lebar Road #06-03  
Singapore 409030

Tel: +65-6749 8866

Fax: +65-6749 3266

E-mail: [sales@datavideo.sg](mailto:sales@datavideo.sg)

## **Datavideo Hong Kong**

Datavideo Hong Kong Ltd  
G/F., 26 Cross Lane  
Wanchai, Hong Kong

Tel: +852-2833-1981

Fax: +852-2833-9916

E-mail: [info@datavideo.com.hk](mailto:info@datavideo.com.hk)

## **Datavideo France**

Datavideo France s.a.r.l  
Cité Descartes 1, rue Albert Einstein  
Champs sur Marne

774477-Marne la Vallée cedex 2

Tel: +33-1-60370246

E-mail: [info@datavideo.fr](mailto:info@datavideo.fr)

## **Datavideo India**

Datavideo Technologies India Pvt Lt  
A-132, Sec-63, Noida-201307,  
Uttar Pradesh (UP), India.

Tel: +91-0120-2427337

Fax: +91-0120-2427338

E-mail: [sales@datavideo.in](mailto:sales@datavideo.in)



Please refer to our website for update the latest version manual.

[www.datavideo.com/product/BC-80](http://www.datavideo.com/product/BC-80)

**datavideo**  
[www.datavideo.com](http://www.datavideo.com)

All the trademarks are the properties of their respective owners.  
Datavideo Technologies Co., Ltd. All rights reserved 2018

Apr-07.2017